

NOTE: All Assembly Order Numbers are for bead plate parts unless noted otherwise.

	Description	Assembly Order No.
Style 1T19L-11	Blind nuts, 1/4 NPT	W01-358-9155
	Blind nuts, 1/4 NPT, bumper	W01-358-9156
Two Ply Bellows	Blind nuts, 3/4 NPT	W01-358-9153
	Blind nuts, 3/4 NPT, bumper	W01-358-2132
	Countersunk steel bead ring, 1 3/4 bolts, nuts, washers	W01-358-9162
Assembly weight.....		10.25 kg.

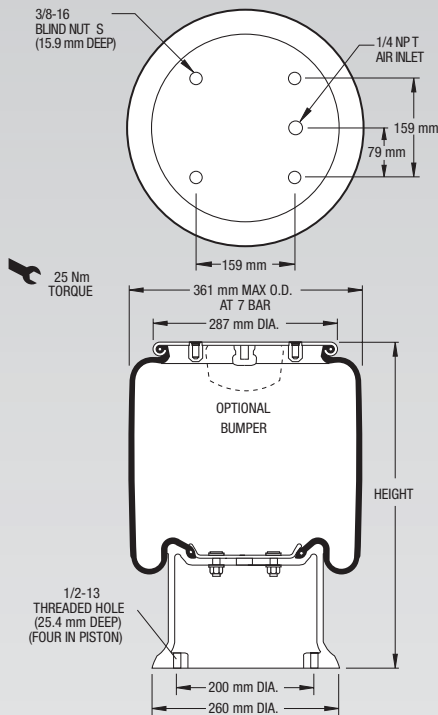

NOTE: Bellows will not compress properly with less than .7 BAR internal pressure.

NOTE: A bead plate part is shown. This part is also available with a bead ring. Bolts are not included. See pages 8-10 for explanation.

Dynamic Characteristics at 455 mm Design Height (Required for Airmount isolator design only)			
Gauge Pressure (BAR)	Load (kN)	Spring Rate (kN/m)	Natural Frequency Hz
3	16.22	76	1.08
4	21.90	96	1.04
5	27.77	117	1.02
6	34.04	140	1.01
7	39.63	160	1.00

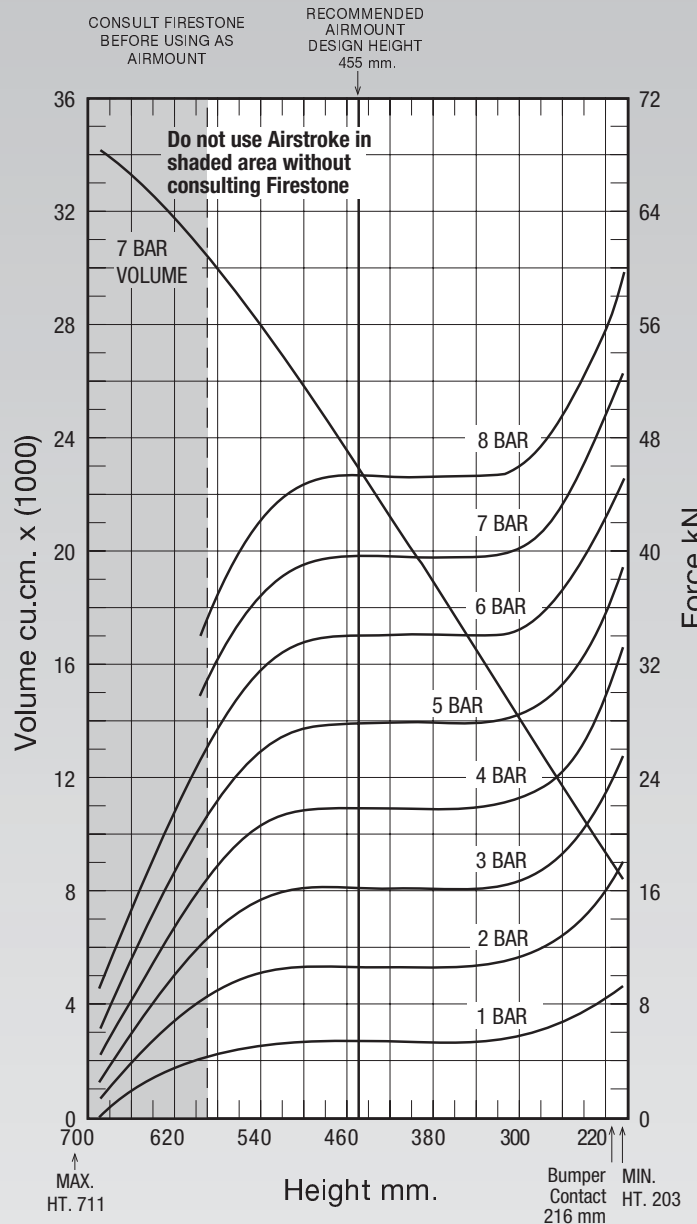

See page 12 for instructions on how to use chart.

Force Table (Use for Airstroke™ actuator design)							
Assembly Height (mm)	Volume @ 7 BAR (cu cm)	EFF Area @ 7 BAR (cm sq)	kN Force				
			@ 3 BAR	@ 4 BAR	@ 5 BAR	@ 6 BAR	@ 7 BAR
580	29938	462	13.45	18.02	22.57	27.62	32.34
540	28011	525	15.32	20.56	25.83	31.49	36.72
500	25891	557	16.09	21.66	27.35	33.44	38.95
460	23607	566	16.22	21.90	27.77	34.03	39.62
420	21262	566	16.22	21.90	27.77	34.04	39.63
380	18895	566	16.22	21.90	27.77	34.04	39.63
340	16461	566	16.22	21.94	27.80	34.04	39.63
300	13995	575	16.79	22.58	28.40	34.58	40.25